

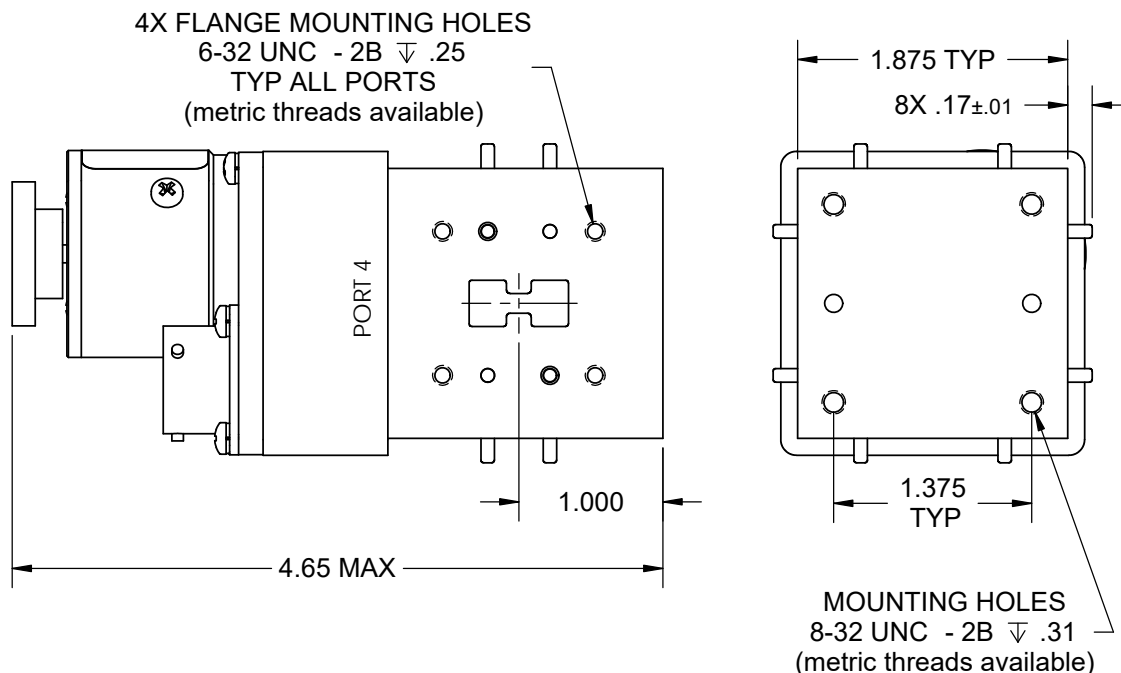

Ridgeguide Switch - MM Series - TTL - WRD750

REV. A

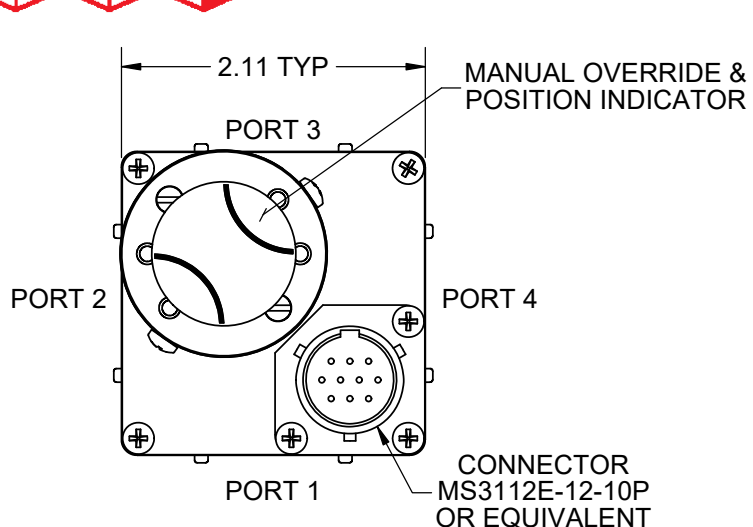

Operating Notes:

- Active logic switch command duration must be greater than 100 mS.
- Maximum switching rate not to exceed 30 per minute.
- Supply to Pin D (Pos. 1) or Pin F (Pos. 2) is 3.0 to 5.5 Vdc. Current draw is 5 mA @ 5 Vdc.

Frequency: 7.5 to 18.0 GHz
 VSWR: 1.15:1 Max.
 Insertion Loss: 0.30 dB Max.
 Isolation: 60 dB Min.

Flange: See Flange Table
 Voltage: See Voltage Table
 Switching Time: 100 mS Max.

Material: Aluminum (RF Assy)
 Finish: Iridite per MIL-DTL-5541
 Paint Dull Black Enamel
 Pressure: 30 PSIG (RF Head Only)
 Drive: Patented Logus I Motor

Temp: Operating: -40°C to +85°C
 Non-Operating: -55°C to +100°C
 Humidity: 0 to 95%, No Condensation

(See Model # Chart to select options)

ELECTRICAL CIRCUIT OPTIONS	
NO INDICATORS	
1 SET INDICATORS	
2 SETS INDICATORS	
3 SETS INDICATORS	
4 SETS INDICATORS	
INHIBIT CIRCUITS	

FLANGE OPTIONS	
COVER	
GROOVE	

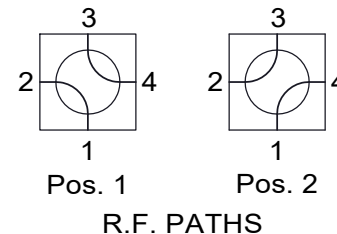

DRIVE OPTIONS	VOLTAGE OPTIONS
LATCHING	12 VDC
PULSE LATCHING	15 VDC
FAILSAFE	24 VDC
	28 VDC
	48 VDC
	115 VAC

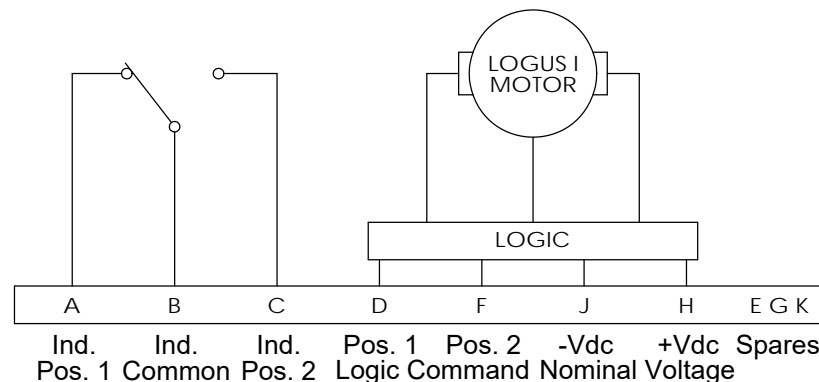

LATCHING, TTL SHOWN IN POSITION 1

(See Schematic page for optional Electrical Circuits)